

# SPINNOVATION

Customer Magazine • No. 36 • June 2021

**New Tools to Compete in the DTY Market**

Two unique concepts for today's texturizers

# CONTENTS

## TECHNOLOGY

- 04 **A Proper Tool for the Competitive DTY Market**  
SSM offers the perfect concept for large quantities of commodity yarns
- 
- 07 **Competing in the DTY Specialties Market**  
The SSM single-position machine concept for various applications
- 
- 10 **Circular Combs and Top Combs for All Applications**  
Highest fiber yield at consistently high productivity with Graf's comb system
- 
- 13 **Spinning Recycled Carbon Fibers**  
A crucial factor: Bräcker ring and traveller systems for special fibers

## PRODUCT NEWS

- 16 **Carding of High-Trash Cotton**  
No compromises on quality and lifetime
- 
- 17 **Lower Ends Down Rates – Higher Productivity**  
Suessen's Performance Package optimizes the compact-spinning system EliTe
- 
- 20 **COMPACTapron – 3D Compacting for Higher Yarn Strength**  
The second generation of lattice apron compacting technology has arrived

## MILL REPORTS

- 22 **The Cost-Efficient Solution Recognized for its First-Rate Performance**  
Increase profit with EASYdoff crowns – insights from Suraj Cotton Mills
- 
- 24 **A Fruitful Cooperation Built on Trust**  
COMPACTeasy – Quality and consistency met highest expectations from Matin Spinning Mills
- 
- 26 **State-of-the-Art Grinding System Ensures Consistent Yarn Quality**  
Investing in a BERKOL multigrinder MGLQ has paid off for Manifattura di CENE

## SPINNOVATION

**Editor in Chief:** Serge Entleitner  
E-Mail: [rco@rieter.com](mailto:rco@rieter.com)  
[www.rieter.com](http://www.rieter.com)

Published by the five companies

**Bräcker AG**  
Obermattstrasse 65  
8330 Pfäffikon-Zurich  
Switzerland  
[www.bracker.ch](http://www.bracker.ch)

**Graf + Cie AG**  
Bildaustrasse 6  
8640 Rapperswil  
Switzerland  
[www.graf-companies.com](http://www.graf-companies.com)

**Novibra Boskovice s.r.o.**  
Na Kamenici 2188  
68001 Boskovice  
Czech Republic  
[www.novibra.com](http://www.novibra.com)

**SSM Schärer Schweiter Mettler AG**  
Rüthof 8  
8820 Wädenswil  
Switzerland  
[www.ssm.ch](http://www.ssm.ch)

**Spindelfabrik Suessen GmbH**  
Donzdorfer Strasse 4  
73079 Süssen  
Germany  
[www.suessen.com](http://www.suessen.com)

Copyright: © 2021  
Rieter Machine Works Ltd.,  
All rights reserved.  
Reprints permitted,  
subject to prior approval;  
specimen copies requested.

Front cover: Heated godets of DP5-T

Dear valued customers,

We hope this issue of our Spinnovation magazine finds you well. News coverage on all media channels is still dominated by the pandemic and many trade shows have been postponed. Nevertheless, the market has started to recover and we have seen many positive indications that this trend will continue. We are therefore delighted that ITMA Asia 2021 will take place in Shanghai from June 12 to 16. This important trade show will be a great opportunity to showcase our products and meet you in person again.

Even under the special circumstances due to Covid-19 in the last few months, putting customers first has always been our top priority and is the driving force behind our everyday work. In this issue, we turn the spotlight on our customers and give them the opportunity to share their experiences with our products.

Good examples of this are the Mill Reports about three successful companies. Suraj Cotton Mills Ltd. (Pakistan) explains how they profit from easy maintenance and a consistently low level of ends down thanks to Novibra's universal catching and cutting crown EASYdoff. Matin Spinning Mills (Bangladesh) has successfully switched to Suessen's advanced COMPACTeasy. Furthermore, you can learn in an interview how investing in a multigrinder MGLQ from Bräcker has paid off for Manifattura di CENE (Italy).

We have an exciting story in our technology section about how to compete in the DTY market with two new tools for texturizers developed by SSM, enabling you to maximize your benefits.

We are also pleased to report innovative technology news from Graf. Thanks to the recently developed cylinder wire P-1940S, Graf offers unique opportunities for carding high-trash cotton without compromising on quality and lifetime.

In addition, we present some great product news. The best-in-class compacting device COMPACTapron takes yarn strengths to new heights thanks to its unique 3D technology that guides the fibers smartly through the compacting zone. The Performance Package from Suessen optimizes



the compact-spinning system EliTe, leading to lower ends down rates and higher productivity.

The right choice of ring and traveller system from Bräcker allows optimal spinning of special fibers, such as recycled carbon fibers (rCF). Furthermore, Graf's comb portfolio ensures optimal fiber yield at consistently high productivity and smooth operation for any application on every comber on the market.

We hope you enjoy reading our articles and we would be delighted if you visit us at the upcoming trade shows. Our experts from Bräcker, Graf, Novibra, SSM and Suessen will be there to put your needs, questions and concerns first.

Sincerely yours,

Serge Entleitner

A handwritten signature in black ink, appearing to read 'S. Entleitner', written in a cursive style.

Executive Vice President Business Group Components

## A Proper Tool for the Competitive DTY Market

SSM offers the perfect concept for large quantities of commodity yarns

**False-twist texturing is a cost-competitive sector of the textile industry. One promising strategy to avoid being left behind is producing commodity yarns at medium or bulk rate. To address this requirement and remain competitive in the DTY market, SSM has developed the new false-twist shaft texturing machine TG30-PES.**

SSM GIUDICI FT machines (Fig. 1) have a very good reputation in the polyamide DTY (Drawn Textured Yarn) sector. Thanks to an optimized component surface and a unique yarn path design, they are the first choice of many polyamide producers focusing on producing the highest yarn quality. These features have now been unlocked for polyester DTY producers as well. SSM launched the new shaft texturing machine TG30-PES – the evolution of a proven machine concept.

The mass market is very cost competitive, so in this case the investment cost for a new machine is of great significance. The shaft machine concept offers advantages over the single-position machine concept, as such a design allows lower costs per spindle.

The H-profile shaped machine TG30-PES, allowing a twist stopper free yarn path, is a real advantage when processing fine- or microfiber DTY yarns. This doesn't only apply to polyamide – it is also true for all other materials found in DTY, such as polyester, polypropylene, PBT or PTT. Historically, polyester texturing was performed using "V type" machine profiles, with the drawbacks of lower process efficiency, limitation in the minimum yarn count and higher maintenance costs.

### Key factors for optimal yarn quality

Many factors influence the yarn quality. These include applying the twist in a concentrated process zone (heater, cooling and spindle), eliminating sharp angles in the yarn path, reducing the yarn path length, and eliminating the possible failures due to faulty twist stoppers, damaged bearings or broken ceramic. A short yarn path is a real benefit in terms of achieving maximum production speed. The yarn starts to vibrate at a certain velocity in a phenomenon known as "surging speed." This affects both the process stability and the improvement of the yarn quality.

Thanks to a shorter yarn path, the process speed can be increased, and surging is avoided (Fig. 2 and 3).



Fig. 1: SSM's false-twist shaft texturing machine TG30-PES

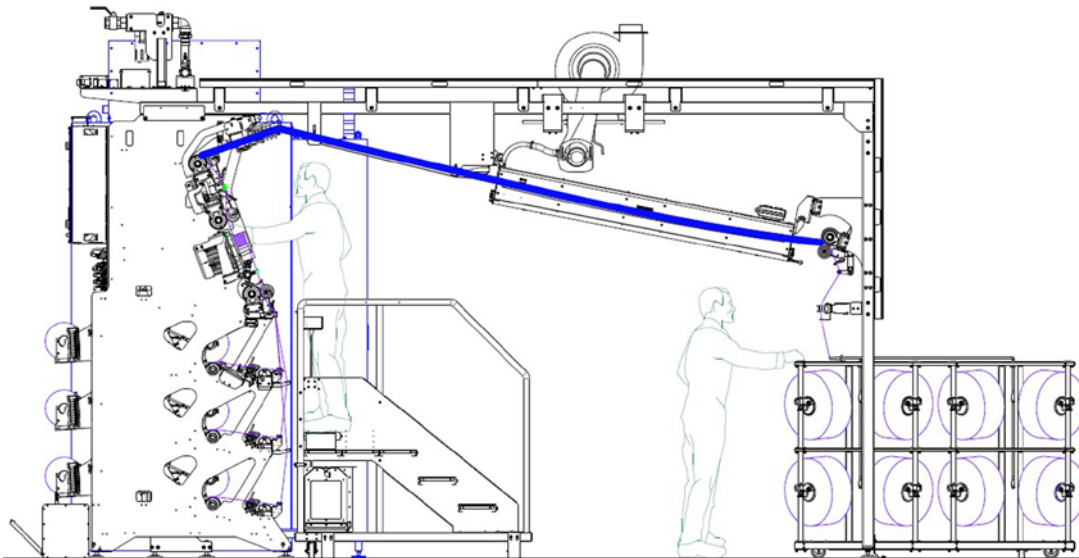

Fig. 2: Advanced yarn path TG30-PES

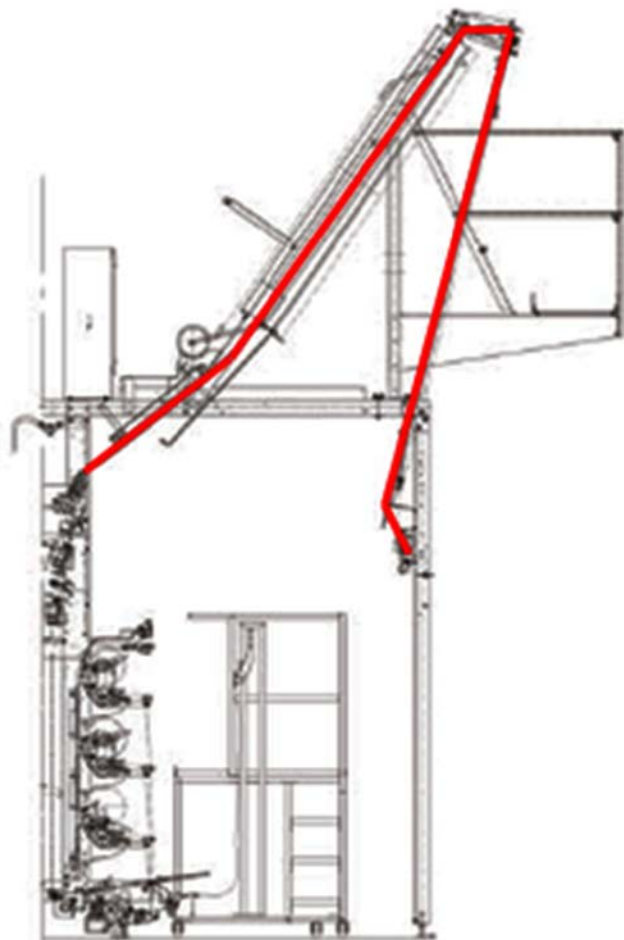

Fig. 3: Common yarn path

Another advantage of the ergonomic shaft texturing machine TG30-PES is that it features the proven electronic traverse guide system – in contrast to previous machine generations that had a traverse guide driven by a mechanical cam system. The cam gears of one deck were driven by a single motor.

Other features, like bobbin's tapering or traverse variation, were performed by mechanical devices and limited in their range. Anti-patterning was done by simply varying the traverse guide velocity based on the principle of random winding. Although common for DTY machines, such anti-patterning systems were not able to fully eliminate pattern zones, especially when processing fine yarn counts where the diameter of the package increases relatively slowly.

#### Benefits of the electronic traverse system

As SSM invented the electronic traverse system, it goes without saying that the system is also used on SSM shaft texturing machines, with the following benefits:

- Maintenance-free operation, no oiling/greasing required
- Elimination of possible oil/grease stains on the packages and therefore on the yarn
- Use of step-precision winding algorithm DIGICONE to produce pattern-free packages, with optimal unwinding performance
- Full flexibility in terms of bobbin's shape, tapering, bulging compensation, etc.
- Marking A/B/C quality packages with a "belly band" winding specific to the bobbin's quality – for fast and error-free sorting of produced packages

## TECHNOLOGY

The TG30-PES machine is supplied with an integrated on-line tension and quality monitoring system GQS for package grading (A/B/C quality). It is operated via the same touch-screen terminal as the machine, which differentiates it from other standalone monitoring solutions.

Furthermore, a heated godet is available on the new shaft machine TG30-PES (Fig. 4). Heat-setting the DTY yarn to achieve the required elasticity is state-of-the-art in the production of polyester DTY yarns, but to use a heated godet to do so is a unique feature of SSM texturing machines.

Unlike the conventional tube heaters used by competitors, heated godets bring the advantages of easier maintenance and superior ergonomics.

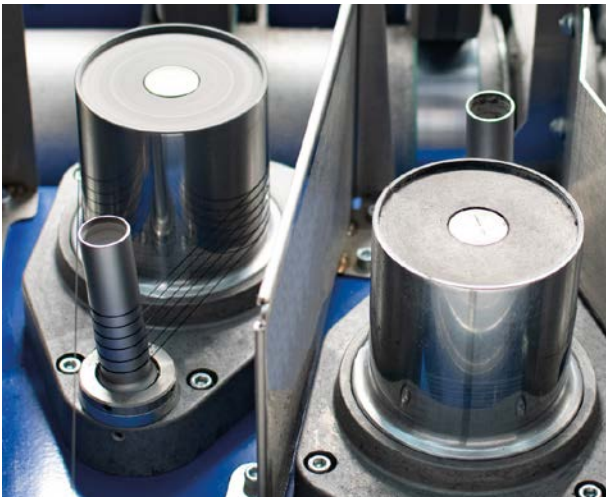

Fig. 4: Heated godets of TG30-PES

### Designed and made in Italy

SSM produces its machines and systems in Italy, with most of the components sourced locally. Every machine is assembled and tested in the SSM factory in Northern Italy.

Well-trained employees ensure trouble-free installation and commissioning at the customer's site and provide a smooth and successful start-up.

### Open-close spindle concept

Every SSM false-twist texturing machine is equipped with open-close type spindles, enabling easy threading even with very fine and delicate yarns. This prevents mis-threading and damage to the friction discs, which can occur when in-

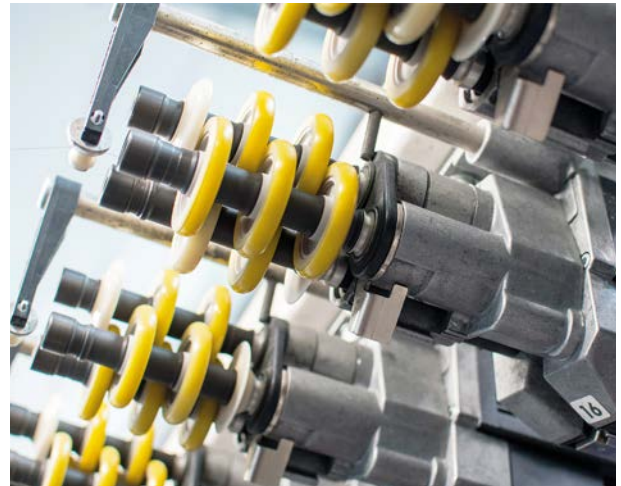

Fig. 5: SSM spindle GS50 running on TG30-PES



Fig. 6: SSM spindle GS50, open-close view

serting the yarn with a comb, especially when using polyurethane disc types (Fig. 5 and 6).

SSM is confident in the advantages of the "H type" machine profile as it results in higher process efficiency, lower yarn count options and reduced maintenance costs.

With the TG30-PES, SSM is offering texturizers the perfect tool to stay competitive in the false-twist texturing sector for medium-size to large bulk production of commodity yarns.



Samuel Paris  
Head of SSM Textile Technology



## Competing in the DTY Specialties Market

The SSM single-position machine concept for various applications

**False-twist texturing is a cost-competitive sector of the textile industry. A winning strategy in this area is to produce specialty yarns with added value. With the launch of the new false-twist texturing machine DP5-FT, SSM is offering the right tool for this specialties market.**

Polyester DTY (Drawn Textured Yarn) was first produced in the 1960s and has since become a commodity yarn. However, over time, polyester yarns have evolved to be used in a variety of specialty yarns, ranging from coarse denier per filament (dpf) to micro-filament and even super-micro-filament yarns. These yarns can be used to produce fabrics with a very soft touch and a light weight.

Filaments with different cross-sectional shapes improve perspiration evaporation or provide the fabric with a distinctive luster. Another specialty is achieved by encapsulating functional chemicals directly into the polymer to create fabrics with additional characteristics such as anti-bacterial properties to eliminate odors or using infrared body emissions to increase body temperature. Furthermore, an increase in dope dyed POY (Partially Oriented Yarn) brings advantages for color fastness and in terms of environmental friendliness, as no subsequent dyeing is required.

All these specialties are the new standard in DTY and bring new challenges for texturizers, e.g., the need for more flexibility in production, as more specialties mean more but smaller lots to be produced. Thanks to the DP5-T, SSM is already in a strong leading position in the air-texturing market; now it is solidifying this position by launching the most flexible false-twist texturing machine, the DP5-FT (Fig. 1).

### A single-position machine concept for full flexibility

An entire DP5-FT machine with 40 positions can be set up with up to 40 different recipes. Every position is almost a standalone false twist (FT) machine with its own heater, control board and is furthermore equipped with individually driven, programmable motors.

---

**Taking the example of a DP5-FT producing 600-denier DTY (4 times 150 denier) on 40 positions, with an efficiency of 95% and 8 000 operating hours per year, the savings are up to 13 000 kW per year, corresponding to the power saved by stopping the affected motors.**

---



Fig. 1: SSM's false twist-texturing machine DP5-FT

Several draw ratios and temperatures can be adjusted between different positions to achieve the best possible result for every color shade of a dope dyed POY – an advantage that sets the machine apart from others in the market.

There is no need to invest in an equivalent laboratory machine. Customers can simply dedicate one or multiple positions of the DP5-FT to trials and sampling. The position(s) can be reassigned back to normal production later to maximize efficiency and reduce sampling costs.

The individual position concept also brings advantages in terms of power consumption and production efficiency. Unlike shaft machines, the power consumption of a position is reduced when it is not in use, as all affected motors are stopped. Moreover, a power-saving function can be activated after a certain amount of idle time has elapsed to reduce the temperature of the heater and godet – maximizing the

---

**Using a 150-denier polyester DTY running at 700 m/min, with doffing occurring every 343 minutes for 4.0-kg full package weight:**

**A machine with 40 positions, operating 8 000 hours per year, can produce 53 000 full packages at 95% efficiency. On a conventional shaft machine, each doff generates 4.4 g of waste, resulting in a total of 233 kg per year.**

**The DP5-FT can slow down the speed during doffing to e.g. 150 m/min, generating only 0.86 g of waste per doff. This results in an over 80% reduction in waste generated during doffing – from 233 kg down to 45 kg (Fig. 2).**

---

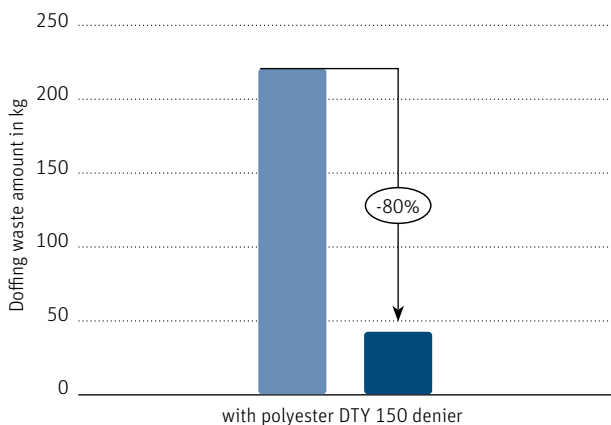

**Fig. 2:** Waste saving with polyester DTY 150 denier

potential savings. On a running shaft machine, it is also common to find positions without yarn, because a wrap after a yarn break cannot safely be removed while running, or because a faulty position is awaiting the next machine stop. There are no such limitations with an individual position machine concept because each position can be stopped individually and serviced immediately, resulting in higher machine efficiency.

Further savings can be made by lowering the heat-setting godet's temperature without altering the machine efficiency, as the SSM induction-heated godets recover their set temperature in a very short time.

Last but not least, the DP5-FT is the first choice for manufacturers whose top priority is personal safety, as the individual position concept allows the use of much smaller motors, limiting the risk of severe injuries to operators.

**Impressive reduction of waste during doffing**

Developing specific software features enables the yarn delivery speed to be reduced during doffing, which in turn significantly reduces yarn waste – a unique benefit compared to shaft machines that use the same motor for all positions and varying doffing times.

The higher the yarn count, the higher the savings. Reducing the doffing waste by up to 73% for a 1 200 den (4 times 300 den) yarn (Fig. 3), corresponds to an impressive reduction of waste of more than 5 tons per year. With a price of 1.3 USD/kg for polyester POY, this feature allows savings of up to 6 500 USD per year on raw materials for a machine with 40 positions.

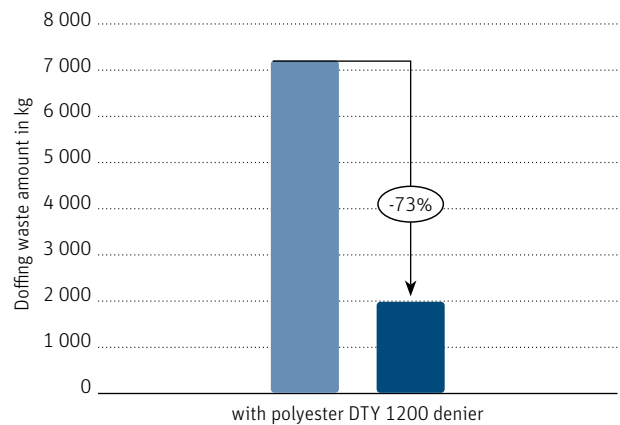

**Fig. 3:** Waste saving with polyester



### Flexibility to increase production capacity

The high flexibility of the DP5-FT is reflected in the minimum available number of five positions only, making it the perfect solution for customers entering the DTY business. It enables full flexibility in terms of lot sizes, types and counts of DTY yarns as well as better control of the supply chain. If a customer later wants to increase the DTY production capacity, the machine can be extended to include up to 40 positions without changing the head stock and using the same machine terminal.

### A substantial cost reduction

The optional elastane feeder is another asset of the DP5-FT. It allows a single-step production of air covered yarns, which consist of DTY and elastane that are combined using an air-jet. SSM comparative tests proved that a higher quality of air covering is achieved if both the texturing and air-covering processes are combined in one single step. Freshly produced DTY features higher elasticity and thus allows optimum relaxation in the air-jet for superior covering quality – compared to a conventional two-step process where DTY is air covered on a dedicated machine. Reducing the air-jet pressure from four to three bar does not just lead to superior yarn quality – it also reduces costs. In numbers, it means a substantial cost reduction of more than 4 000 USD annually for a 40-position machine operating for 8 000 hours.

The DP5-FT is supplied in a double density version with two spindles per position as standard to produce 2-ply yarns at the highest level of efficiency. Optionally, up to four spindles per position can be installed to produce 4-ply yarns without losing productivity, as all take-up is used in this configuration. Carpet yarn producers highly appreciate this setup, as it enables them to produce 1 200 denier (4 times 300 den) balanced yarns (2 S twists + 2 Z twists) in one single step and thus maximizes their productivity.

The DP5-FT can also be equipped with a second drawing roller for producing plied yarns using various materials. For example, polyester/polyamide can be used simultaneously on the same position, as both materials can be drawn independently at different levels. This option means trendy DTY yarns can be produced, e.g. two-tone yarns made of the same material but drawn at different levels, resulting in differing dye absorption to get special color effects. These types of yarn are in high demand from the fashion industry.

### Full control and inspection without stopping the machine

A unique feature of SSM texturing machines is the heated godet (Fig. 4) to heat-set the DTY yarn and achieve the re-

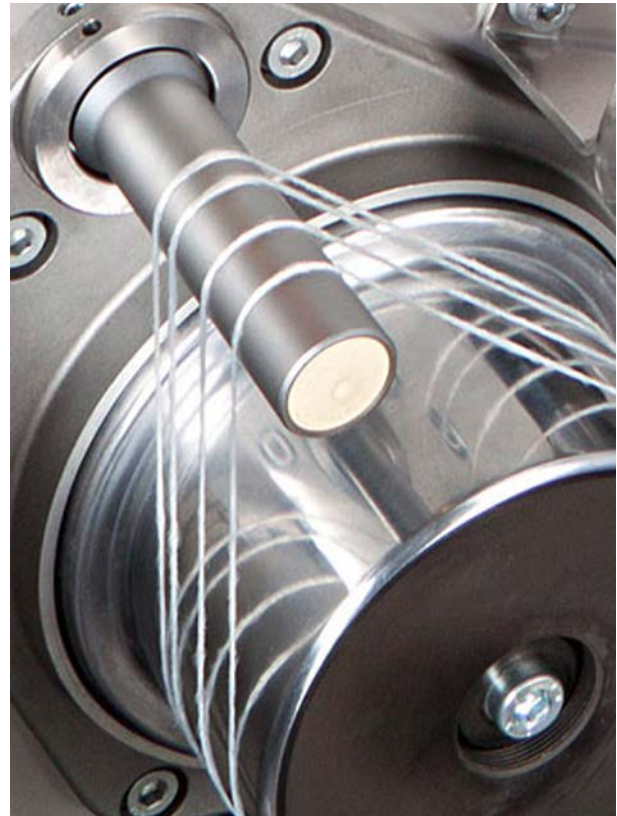

Fig. 4: Heated godets DP5-FT

quired elasticity. This is state-of-the-art in the production of polyester DTY yarns. Due to their length, tube heaters on competitors' machines are installed at the rear of the machine or underneath the catwalk. Therefore, operators can't inspect them during production or remove the internal tube periodically for cleaning. On SSM texturing machines, the heat-setting godet is located at the front of the machine, enabling full control and inspection of the entire yarn path at any time without stopping the machine. Instead of using a tube heater with a predefined length, using a godet also allows operators to influence the duration of the heat setting process by increasing or decreasing the number of wraps around the godets.

With this modern machine concept, SSM offers texturizers a proper tool to stay at the forefront of the competitive DTY specialty market.



**Samuel Paris**  
Head of SSM Textile Technology



## Circular Combs and Top Combs for All Applications

Highest fiber yield at consistently high productivity with Graf's comb system

**Yield, yarn quality and productivity are the key requirements in combing. Spinning mills using Graf combs benefit from up to 0.5% higher yield, 20% fewer imperfections and service lifetime extended at least 20%. The comprehensive comb portfolio ensures smooth operation for any application on every comb.**

By investing in a combing process, a spinning mill is able to serve the market segment for finer yarn count ranges of high quality and achieve higher prices for the yarn. In addition to the factors listed above, maximum raw-material utilization is also essential in combing. Only the short fibers are to be eliminated, while the good fibers must be retained in the process.

### Combing expertise at a glance

A staple fiber diagram explains the importance of precisely and accurately eliminating short fibers during the combing process (Fig. 1). It indicates that as the number of good fibers in the noil decreases the raw-material utilization

increases in terms of achieving maximum yield. Conversely, it means that the fewer short fibers are in the combed sliver, the higher the yarn quality.

The installation of the uniquely performing combs from Graf and perfectly aligned machine settings across all combing positions ensure an optimal result:

- Top combs from the FIXPRO and the Ri-Q-Top series accurately prevent short fibers from passing through and ensure that they are presented to the circular combs
- Circular combs from the PRIMACOMB and Ri-Q-Comb flex series gently remove the unwanted short fibers and any remaining neps without damaging the good fibers
- Circular combs Ri-Q-Comb flex are unique in that their height can be adjusted, which helps to provide a perfect parallel alignment between the circular combs and the nippers. This ensures an even higher level of precision for the combing process, resulting in even higher sliver quality and yield



Consistent combing results combined with 20% longer lifetime

Graf's comb solution portfolio provides the perfect comb package for any comber installed in the market (Fig. 2).

**Most selective top comb thanks to unrivaled tooth design**

Top combs from Graf ensure an optimal filter function for short fibers in the sliver. The secret is the perfect design of a wide tooth profile – paired with a parallel free vertical space between the teeth. This prerequisite ensures that the fiber fringe, consisting of accumulated short fibers, is perfectly presented to the circular comb.

Both top comb series, FIXPRO and Ri-Q-Top, are characterized by a particularly smooth tooth surface, which prevents soiling and the absence of wrapped fibers to ensure a uniquely safe production process. This unrivaled surface treatment also ensures immediate start-up to the desired production rate. Furthermore, spinning mills using Graf top combs benefit

from the longest service lifetime available, which is up to 20% longer than other models on the market, thanks to the alloy CUTTYSHARP. The special assembly design of the teeth in a groove ensures unique robustness and an absolute straight alignment of the top comb's teeth (Fig. 3).

**Optimize margins with Graf circular combs**

Whether it's a PRIMACOMB or Ri-Q-Comb flex model, Graf circular combs are known for maximal production reliability thanks to their robust and continuously optimized design and manufacturing processes that have been proven over decades. These circular combs reduce imperfections by up to 20% thanks to an unrivaled tooth design across the comb sections (Fig. 4 and 5). In addition, the spinning mill benefits from minimal investment costs, due to at least 20% longer service lifetime – made possible by the extremely wear-resistant alloy CUTTYSHARP.

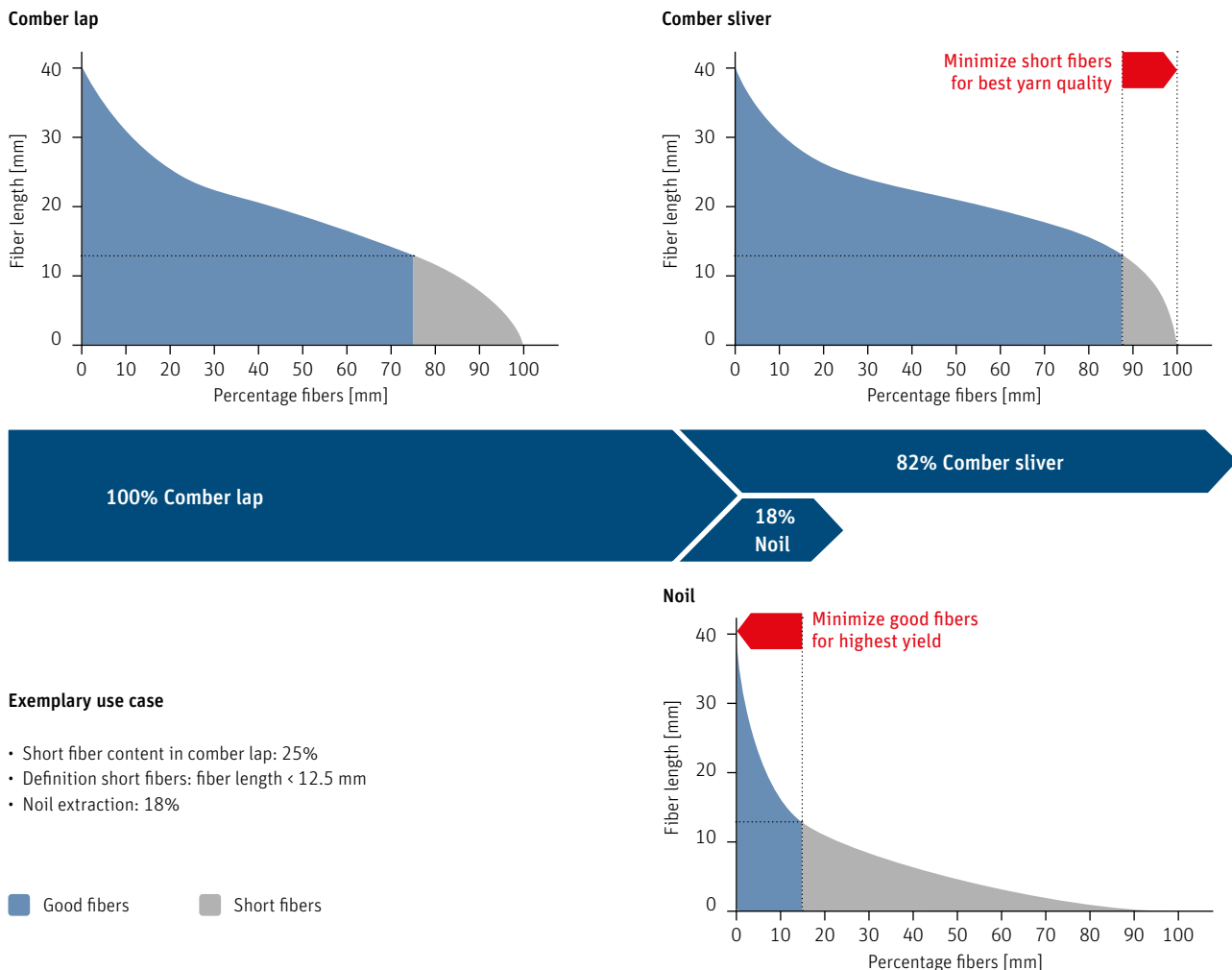

Fig. 1: Staple diagram explains the way of short fibers

**Exemplary use case**

- Short fiber content in comber lap: 25%
- Definition short fibers: fiber length < 12.5 mm
- Noil extraction: 18%

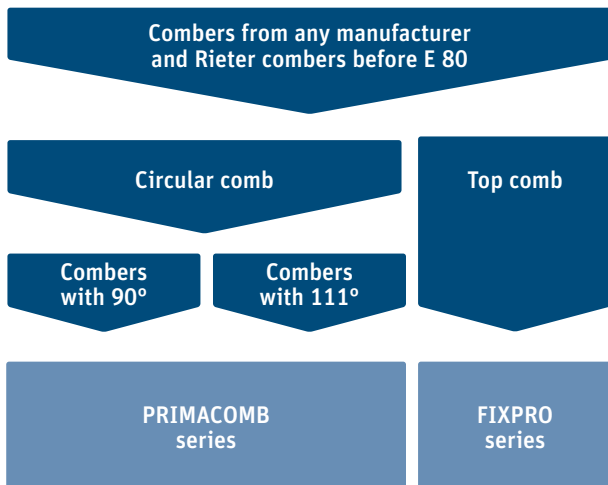
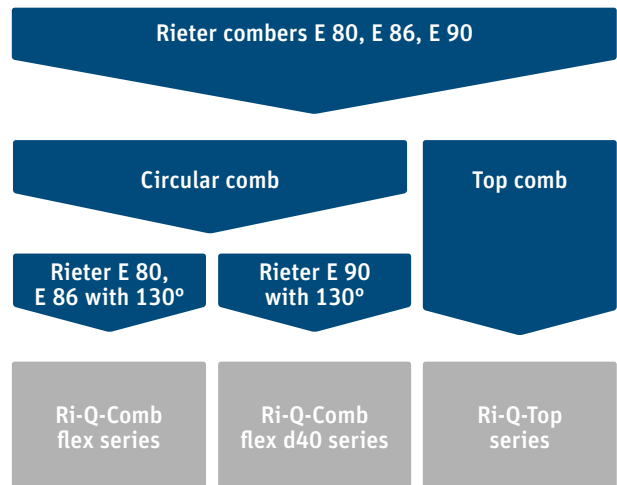

Fig. 2: The perfect match for any customer requirement



Another very relevant advantage of all Graf combs is minimal soiling of the clothing as a result of the extremely smooth surface provided by the unique needle-finish surface treatment. As a premium, all Ri-Q-Comb flex combs offer a yield increase of up to 0.5%. The unique height adjustment feature allows a very ergonomic mechanism to perfectly adjust the parallelism between the nipper and the circular comb (Fig. 4 and 5).



Fig. 3: Perfect alignment of tooth width and free vertical space between the teeth

In summary, spinning mills can rely on highly effective Graf combs to remove short fibers and neps while keeping the good fibers in the process. These advantages result in lower conversion costs for the yarn produced. The particularly long service life further increases the overall efficiency of the spinning mill. Moreover, all mills can rely on their partnership with Graf, as it is based on innovation, service expertise and technical support – and therefore on the best possible value for money.

The optimal number of sections from coarse to fine clothing ensures correct short fiber selection while avoiding any damage to the good fibers.

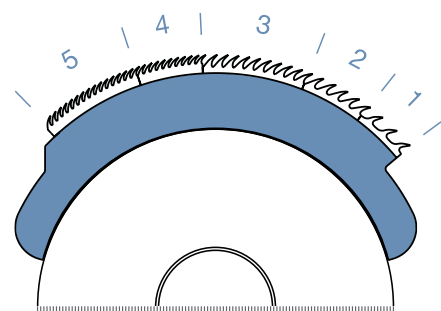

Fig. 4: Exemplary section of circular comb PRIMACOMB

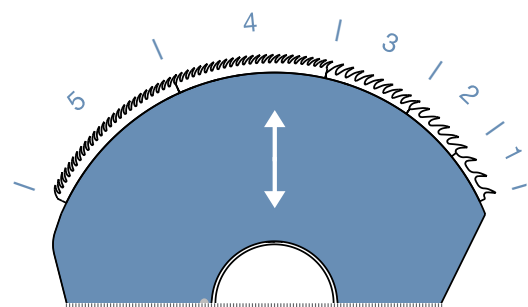

Fig. 5: Exemplary section of circular comb Ri-Q-Comb flex



Christian Liechti  
Product Manager



## Spinning Recycled Carbon Fibers

A crucial factor: Bräcker ring and traveller systems for special fibers

**When spinning special fibers such as recycled carbon fibers (rCF), it is crucial to use the optimal ring and traveller (R/T) system. As part of a preliminary research study at the German Research Institute for the Textile Industry (DITF), various Bräcker R/T systems were used on a ring spinning tester and the systems were evaluated to determine which are the most suitable for spinning rCF.**

Carbon fiber reinforced plastic (CFRP) is a genuine high-tech material. It is most often used when other materials have reached the limits of their load capacity. To produce CFRP parts with a low mass and better rigidity, higher costs must be accepted.

Although it has the same mechanical characteristics, CFRP is up to five times lighter than steel and is only 60% of the weight of aluminum. It also offers characteristics such as high fatigue strength, X-ray transparency, corrosion resistance and adjustable thermal expansion.

Today, CFRP is most commonly used in aviation and aerospace applications, as well as the automotive industry and wind energy generation. CFRP is also used in medical technology, robotics, automation technology, measuring technology and optical lens technology, as well as sports equipment such as high-quality bicycle frames, rowboats, fishing rods and much more. In 2018, global production of CFRP was over 130 000 tons at an annual growth rate of more than 10%.

### Recycled carbon fibers (rCF)

The manufacturing process for CFRP requires a very high level of energy. To compensate for this fact, recycling the material is an attractive option that does not reduce the excellent characteristics of CFRP.

Spinning rCF into staple fiber yarns in combination with thermoplastic matrix fibers is an approach that represents an alternative to conventional recycling methods. Compared to webs, staple fiber yarns enable a better orientation of the individual carbon fibers. In this way, the considerable performance potential – from a structural mechanics perspective – of the carbon fibers in the structural fiber composite is largely retained. This allows further processing into woven fabrics, non-crimp fabrics, mesh, or packages on conventional machines. One variant is to produce rCF yarn on modified ring spinning machines.



Traveller with CARBO finish

### An experiment using the DITF ring spinning tester

As part of a preliminary research project, ring yarns made from rCF/polyamide 6 fibers (PA 6) were produced at the DITF. The hybrid yarns were spun from card slivers with a blend ratio of rCF to PA 6 of 45% by weight to 55% by weight.

The yarn was produced at the DITF on a ring spinning tester (built by the DITF) with six spinning units for sliver spinning. A yarn with a yarn count of 100 tex and a twist factor of am 120 was spun in this project.

Bräcker supplied the following rings and travellers to the DITF in advance for this spinning project:

- The travellers M/EM 1 dr and C 1 SM fr for T-flange rings. Customers use these types of traveller successfully with very aggressive fibers, such as Kevlar and aramid, on TITAN rings with flange 1 (Bräcker AG Spinning Data).
- The traveller SU-BM drh for SU rings. The SU ring/traveller (R/T) system offers clear advantages when using man-made fibers and blends with coarse yarn counts. Thanks to the large contact surface between the ring and the traveller, the specific surface pressure is reduced so that optimal heat dissipation from the traveller to the ring is achieved.

### Ring spinning process and ring/traveller system

Determining the optimal R/T system is essential to ensuring the best individual performance is achieved. If the ring profile and the type of traveller are well coordinated, the traveller will sit in a stable position on the ring. This prevents any impairments in operation, particularly during start-up.



SU Ring

The crucial factors in this regard are the space between the traveller and the ring for the yarn to pass through as well as the R/T contact surface or the distance between the R/T. The space between the traveller and the ring must be of a sufficient size to ensure that the yarn does not become stuck – this prevents ends down and yarn damage.

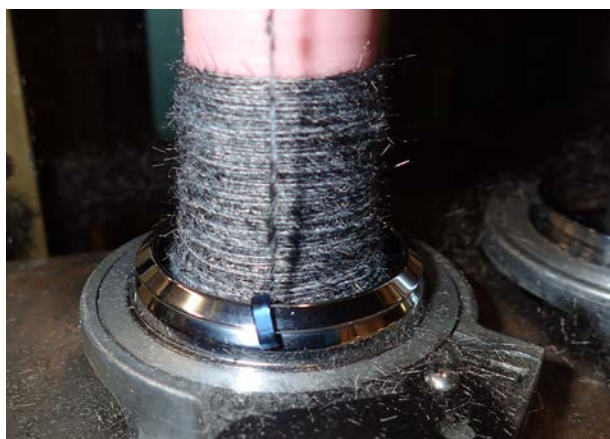

Ring Spinning Tester with SU-R/T system

Another important parameter for running behavior and yarn quality is the weight of the traveller, which must be adapted to the yarn count that is to be produced. In this context, factors such as the spindle speed, delivery speed, balloon size and cop hardness must be taken into account.

Fluctuations in the tensile force of the thread, vibrations in the rotating cop and traveller vibrations also play an important role in the R/T system. The tilting motions and vibrations of the traveller are partially responsible for fluctuations in the tensile force of the thread, as well as noise development and wear. These movements and vibrations are heavily influenced by the eccentricity of the spinning elements (cop, ring, balloon control ring, yarn guide), the movements of the cop, the balloon stability and the yarn characteristics. When it comes to yarn characteristics, the rCF yarns are subject to major fluctuations in yarn count.

Severe wear of the traveller results in a higher ring load, changes in the winding tension and balloon tension, and a smaller space between the traveller and the ring for the yarn

to pass through. If the traveller is regularly changed at the correct time, this not only prolongs the service life of the ring but also achieves a more even yarn quality.

The following factors represented additional challenges for the R/T system in the experiment with recycled carbon fibers:

- Fluctuating evenness of the card slivers caused numerous thick places, which remained stuck in the traveller and sometimes resulted in ends down
- Significant changes in the yarn evenness and the associated fluctuation in the forces in the spinning zone and in the area of the R/T system
- Fluctuations in mass, which made it much harder to adapt the weight of the traveller to the target yarn count
- Frequent ends down (starting/stopping the traveller)
- rCF dust accumulated on the running surface of the traveller, increasing the R/T friction and the associated traveller wear

#### **Determining the most suitable ring/traveller system for fine-spinning of rCF**

As expected, the SU-R/T system achieved the best running behavior with the TITAN ring with a diameter of 42 mm from Bräcker. The ring is ideal for processing very sensitive synthetic fibers and their blends. The fact that this ring requires no lubrication is also beneficial for rCF spinning.

The SAPHIR traveller SU-BM drh provides a wider space between the traveller and the ring for the yarn to pass through, which is particularly advantageous for the rCF fibers. The poor quality of the card sliver in this project led to considerable fluctuations in the yarn count. This had a negative impact on the movement of the traveller, which caused it to become worn more quickly. This was made worse by the high level of rCF dust formation.



Traveller with STARLETplus finish

It is possible that the SU-R/T system could be used successfully for yarn production if a more even card sliver is used than that processed as part of a preliminary research project and if the rCF dust formation is reduced.

For aggressive fibers, the high-tech travellers STARLETplus and CARBO are recommended in the spinning mill as they significantly reduce wear on the ring traveller.

Due to the better spinning stability and longer service life, the yarn production required in the project was completed with the traveller C1 SM fr SAPHIR on the T-flange spinning ring.

In summary, it can be stated that the ring spinning method – using the appropriate Bräcker R/T system – is very well suited to spinning rCF.



**Brigitte Moser**  
Product Application and R&D

**Bräcker**

## Carding of High-Trash Cotton

No compromises on quality and lifetime

**Graf offers unique opportunities for carding cotton with a high trash content of 5% and above – without any limitations on the sliver quality and wire lifetime. When processing standard cotton with an average trash content, spinning mills benefit from an extended lifetime of up to 10%.**

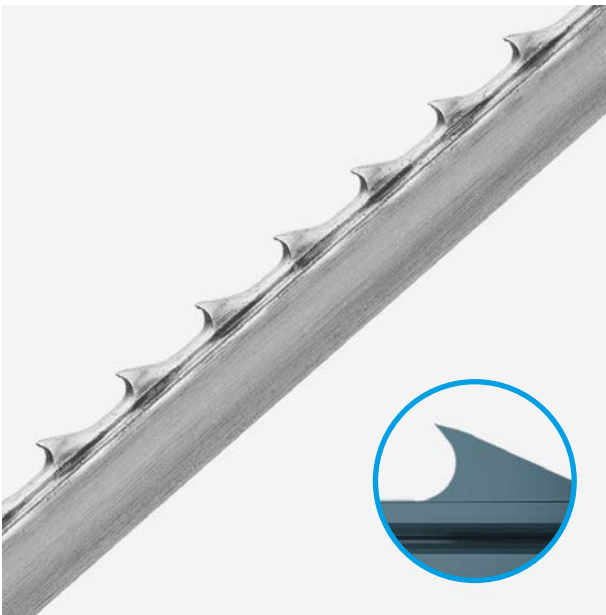

Novelty cylinder wire P-1940S

The trash content in cotton varies over time and generally tends to increase due to mechanical harvesting principles. The unique tooth shape and the considerably larger tip area of the newly developed cylinder wire P-1940S provide an extremely robust carding process behavior and therefore cope with high trash contents without compromises on the carding's essential characteristics. Perfect parallelization of the fibers and adequate nep removal are ensured throughout the entire operation.

Does a higher trash content shorten the lifetime of the cylinder wire? It does for many wires on the market, but not for the P-1940S. Thanks to its wider blade width, the P-1940S can cope with higher trash contents without compromising its service life. In other words, the P-1940S ensures an extended lifetime of up to 10% longer than the proven market-leading cylinder wire P-2040S used for cotton with a low trash content.

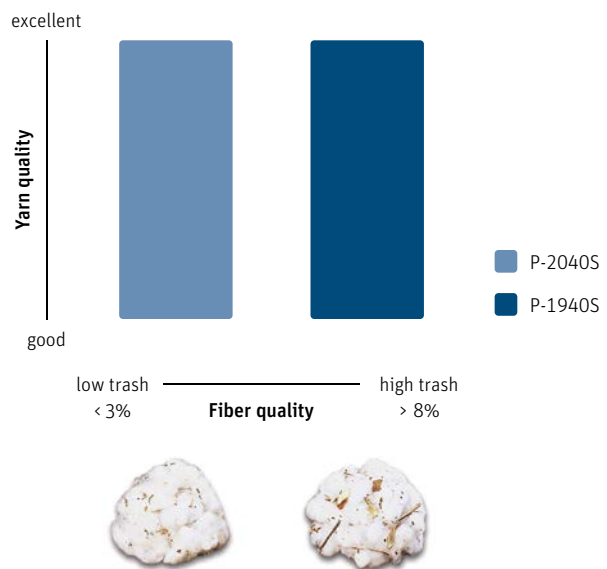

The graphic perfectly shows the performance of the cylinder wires P-1940S and P-2040S in terms of sliver quality and the trash content of the raw cotton, while ensuring the same lifetime.

Spinning mills striving for maximum service life also have the option of changing the alloy from the well-proven industry-standard CUTTYSHARP to the uniquely wear-resistant alloy MULTISHARP, which extends the lifetime by an extra 50%.



**Christian Liechti**  
Product Manager





## Lower Ends Down Rates – Higher Productivity

Suessen's Performance Package optimizes the compact-spinning system EliTe



Fig. 1: COMPACTeas spinning system

**The combination of the top weighting arm P3-1 together with the Performance Package allows further enhancement of the proven compact-spinning system EliTe. Thanks to the Performance Package, ends down rates are reduced, spindle speeds increased and productivity is therefore significantly higher.**

Suessen's EliTe is the most versatile, flexible and in-demand compact-spinning system on the market. All of the proven benefits are further enhanced when used in combination with the top weighting arm P3-1 and the Performance Package. It is perfectly suited for cotton and for blends with cotton.

Since the launch at ITMA 2019 in Barcelona, the Performance Package has been installed on around 1.5 million EliTe spindles with great success.

### Significantly higher speed and productivity

It goes without saying that Suessen constantly strives to offer customers a competitive advantage. The aim of the Performance Package was to increase production and get lower numbers of ends down. The top weighting arm P3-1 in combination with the Performance Package influences the geometry of a ring spinning machine. The EliTop offset is increased from the standard 4.5 mm to 6.5 mm. This results in a reduction of ends down rates by up to a considerable 25%.

Many customers using the Performance Package have been able to increase the spindle speed significantly. As it can be accelerated by 1 000 to 2 000 rpm, a much higher productivity is consequently achieved. Another striking advantage for the customer is the relatively low investment cost, which results in a fast amortization.



Fig. 2: Bracket EliTe P3-1

### Components, versions and easy installation

The complete Performance Package “basic” consists of all the following components:

- The bracket is replaced by the bracket EliTe P3-1 because the front pressure roller is loaded using the leaf spring (Fig. 2).
- The leaf spring EliTop P3-1 is needed to load the front pressure roller of the EliTop (Fig. 3).
- The front distributor P3-1 is used to achieve the increased offset of 6.5 mm (Fig. 4).
- The suction head Pelican (nozzle 10.0 and 8.5 plus end piece) avoids successive ends down, as it becomes clogged much less than a standard suction head (Fig. 5).



Fig. 3: Leaf spring EliTop P3-1



Fig. 4: Front distributor P3-1



Fig. 6: JETsert



Fig. 5: Pelican suction head (nozzle 10.0 and 8.5 + end piece)

EliTe, in combination with the Performance Package, requires the insert JETsert to be installed on the EliTube Classic Shape when changing the offset from 4.5 mm to 6.5 mm (Fig. 6). As many customers now use JETsert as a standard, two additional versions of the Performance Package are available alongside the basic package. These versions are delivered without the Pelican suction head and either including or excluding the JETsert. The installation of the Performance Package is straightforward and can be carried out by an in-house technician using the installation instructions provided by Suessen.

When producing with the compact-spinning system EliTe, it is worth considering purchasing the Performance Package in order to raise the spindle speed and thus significantly increase productivity.



**Frauke Pobric**  
Sales Department  
and Marketing



## COMPACTapron – 3D Compacting for Higher Yarn Strength

The second generation of lattice apron compacting technology has arrived



COMPACTapron takes yarn strengths to new heights

**Yarn strength is crucial in determining the quality of the final spinning product. Following several years of research at Suessen's Research & Development (R&D) center, Wilhelm Stahlecker GmbH (WST), the team found a way to boost yarn strength by up to 1 cN/tex with the latest addition to the compacting family, COMPACTapron.**

The improved raw material yield gives spinners more options to optimize costs so they can choose between twist reduction to enhance productivity, adjusting the raw material mix, or obtaining a higher selling price in downstream processes.

*"Initially, our goal was to improve the pneumatic compact spinning principle which requires a lot of energy, a major pain point for mills,"* explains Dr. Peter Blankenhorn, Head of WST's Research and Development Ring spinning team.



Dr. Peter Blankenhorn, Head of R&D, WST, Ring Spinning Team

All state-of-the-art compacting systems use so-called two-dimensional (2D) compacting which means fibers are condensed on the surface of a mesh apron, perforated apron or on the surface of a perforated drum.

*“But fibers located on the surface of the condensing element are less exposed to the air stream which means they are compacted less effectively,”* adds Blankenhorn.

COMPACTapron transports the fibers in the condensing zone over the suction slot in a distinctive distance to the mesh apron so that all fibers are compacted, hence the term three-dimensional (3D) compacting.

In addition, the distance between the nip lines of COMPACTapron is shorter than the shortest fiber so that fibers are guided smartly through the compacting zone, which

is why COMPACTapron achieves better yarn strengths compared to competitors. Extensive testing in several mills using both long staple and semi-combed cotton have confirmed these findings.

Blankenhorn closes highlighting that COMPACTapron also lowers conversion costs: *“This is an exciting step forward for our customers as COMPACTapron requires less energy, less maintenance, and fewer spare parts.”*



**Ioannis Spiridopoulos**  
Head of Sales and Marketing

**Suessen**

## The Cost-Efficient Solution Recognized for its First-Rate Performance

Increase profit with EASYdoff crowns – insights from Suraj Cotton Mills



NASA HPS 68 with EASYdoff

**EASYdoff from Novibra is suitable for a wide range of applications. Suraj Cotton Mills Ltd. (Pakistan) benefits from a consistently low level of ends down while spinning as well as easy maintenance. They also achieved a lower rate of ends down during start-up thanks to a firm and dependable yarn grip and have not faced any crown damage in five years.**

Incorporated in 1984, Suraj Cotton Mills Ltd. is a public limited company listed on the Pakistan Stock Exchange. It covers state-of-the-art spinning as well as air-jet weaving machinery and places an emphasis on product innovation. Suraj Cotton is a market leader in Pakistan for fine count yarns and operates three spinning units, equipped with 125 000 ring spindles in total. Their products range from Ne 10 to Ne 135 and is used in apparel fabrics, industrial fabrics, knitwear, towels, bed sheets and many other applications. As a manufacturing organization, Suraj Cotton sells its high-quality yarns and fabrics to both domestic and international customers.

### From challenge to solution

In 2015, the Suraj Cotton spinning unit in Shahkot started its first trial with universal cutting and catching crowns EASYdoff on Toyota RX240 frames. Customers often face the

challenge of wear and tear to the spindle underwinding system. Often, replacing the upper part or even the complete spindle was the only option. Novibra has successfully resolved this issue with the replaceable cutter and catcher of EASYdoff. This crown does not just provide very reliable and consistent performance – it is also easy to maintain and does not require any modifications to the machine or its settings.

Novibra service provided additional training for the employees on how to properly maintain and handle the spindles, which helps to prolong the lifetime and to enable full utilization. Today, Suraj Cotton is running 7 192 Novibra NASA HPS 68 spindles with EASYdoff for 100% cotton Ne 40 or finer.

### How Suraj Cotton benefits from EASYdoff

With EASYdoff, Suraj Cotton has achieved a firm yarn grip, sharp cutting and a reliable and consistent ends down rate during start-up. Moreover, this solution can easily be replaced in case of damage. The catching and cutting crown EASYdoff allows agile and flexible mill investment planning when purchasing new machines, replacing spindles or simply replacing the spindle crown. Once the spindles are equipped with EASYdoff, all options are available.

Riaz Khan, General Manager at Suraj Cotton Shakhkot, confirms: *“We have been running NASA spindles with EASYdoff for more than five years now at an average speed of 21 700 rpm, and we are very satisfied with the performance. It is easy to maintain and reliable with only 1.9% of ends down at the doffing stage. It must be noted that this ends down rate of 1.9% applies to manual doffing”*. Khan further discusses his positive experience: *“EASYdoff is highly recommended for cotton process, especially for Ne 40/1 and finer counts. We have achieved a lower rate of ends down during start-up and did not face any crown damage, even after five years of running life.”*



Riaz Khan, General Manager

### A truly universal solution

The design of the catching and cutting crown EASYdoff is based on a well-proven concept. As its application range is universal, there are no limits in terms of speed, yarn count, machine type or Novibra spindle model. It can be supplied as part of a new machine or as an upgrade to existing machines without having to change the settings.

EASYdoff is the perfect solution for customers who want to stay as flexible as possible in terms of future investment planning and at the same time are looking to enhance the performance of their ring spinning machines.



NASA HPS 68 with EASYdoff



Lukáš Častulík  
Area Sales Manager

**Novibra**

## A Fruitful Cooperation Built on Trust

### COMPACTeasy – Quality and consistency met highest expectations from Matin Spinning Mills

**Matin Spinning Mills, Bangladesh, is second to none in terms of its product quality. Thus, its expectations of its suppliers are very high. Being experienced with other mechanical compacting systems, Matin recognized the advantages of Suessen's COMPACTeasy. The very high yarn tenacity and consistency as well as the possibility to run a wide range of fibers and counts convinced the company to order compact-spinning systems from Suessen.**

in 2019. It progressed rapidly under the expert leadership of Mr. Jabbar and was listed on the Dhaka and Chittagong stock exchanges in 2010.

#### **Top-quality yarns matter most**

The company is a market leader in Bangladesh thanks to its top-quality yarns, produced on 72 000 ring spindles, 480 air-jet spinning positions and 1 280 rotor spinning units.



Factory Matin Spinning Mills

The company Matin Spinning Mills, based in Kashimpur, Gazipur (Bangladesh), was founded in 2002 by the four forward-thinking brothers Abdul Wahed (Chairman of DBL Group), M. A. Jabbar (Managing Director of DBL Group), M. A. Rahim (Vice Chairman of DBL Group) and M. A. Quader (Deputy Managing Director and Group CEO of DBL Group). The DBL Group is a large and diversified group with activities ranging from textiles, pharmaceuticals and telecommunications to semiconductors and ceramics. The group employs around 38 000 people and achieved a turnover of USD 600 million

Matin produces over 50 000 kilograms of yarn every day. Counts range from Ne 3 to Ne 70 – virtually all fibers are spun, including cotton, polyester (both virgin and recycled), viscose, modal, tencel and more. The end uses are mostly knitted goods.

As one of the first spinning mills in Bangladesh, Matin noticed the value of compact spinning and decided in 2011 to buy the compact-spinning system EliTe for five ring spinning machines RX 240 with 1 200 spindles each. They had been suc-



successful with compact spinning and wanted to continue with it, but also decided to buy mechanical compacting devices from a competitor.

**Collaboration is key to success**

After Suessen had introduced the mechanical compacting solution COMPACTeasy, Matin recognized the potential advantages compared to its competition and ordered COMPACTeasy for four machines RX 240 with a total of 4 800 spindles. Matin was so pleased with the quality and consistency that they soon placed an additional order for 8 400 spinning positions.



M. A. Jabbar, Managing Director of DBL Group

With any new product, challenges can occur, as was the case with COMPACTeasy. Matin cooperated very openly with our technical and technological team to solve the issues. The Suessen team has learned a lot from working with this professional, very open and cooperative customer to meet their high expectations.



Matin technical team

Today, Matin successfully uses COMPACTeasy for many of their fibers and yarn counts. They even run Ne 30 slub yarn with great success. The main advantage of COMPACTeasy with slub yarn is the highly increased tenacity, as stated by Md. Shamimul Haque, Chief of Operations at Matin. The company is also working on the development of recycled yarn, injected and blended yarn with COMPACTeasy in order to achieve better strength and hairiness.



**Peter Stahlecker**  
Managing Director



## State-of-the-Art Grinding System Ensures Consistent Yarn Quality

Investing in a BERKOL multigrinder MGLQ has paid off for Manifattura di CENE



**Manifattura di CENE has been working with the BERKOL multigrinder MGLQ for top roller and long cots for three years now. The spinning mill manager Dante Caldana and the sales manager Elena Baroni share their experiences with this machine and the benefits for CENE.**

Manifattura di CENE SpA, located in Northern Italy, was founded in 1979 and employs 57 people. The company has two units installed, a ring spinning and a rotor spinning mill, and is specialized in the production of coarse yarn from count Ne 1.8 to Ne 20. A wide variety of fibers are processed on the 20 000 spindles and 800 rotors in the production facility: from 100% cotton to blends with viscose, tencel, bamboo and linen, through to customized slub yarn. A large proportion of the yarn is produced for technical applications and the clothing industry. With great flexibility and a strong customer focus, CENE produces over 1 100 different products. Its main markets are Italy and parts of Europe. Manifattura di CENE SpA is certified to GOTS (Global Organic Textile Standard) and GRS (Global Recycle Standard).

### Enhancing the efficiency of the spinning mill

Manifattura di CENE has relied on proven BERKOL products for many years already – the roll shop is equipped with a BERKOLIZER and BERKOL presses. Three years ago, the company bought its first Bräcker grinding machine, the BERKOL multigrinder MGLQ. In an interview with Spinnovation,

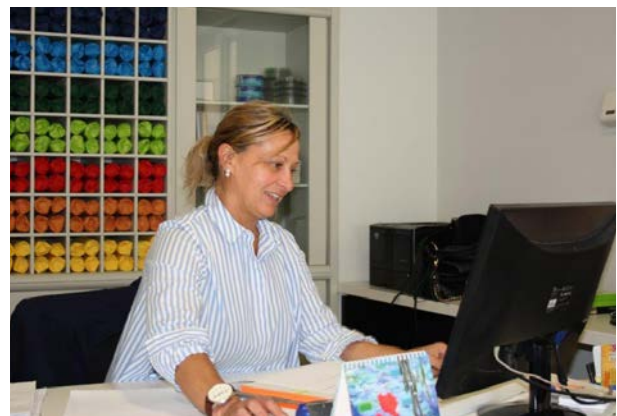

Mrs. Elena Baroni, Sales Manager

Dante Caldana and Elena Baroni shared interesting insights about their experiences with the BERKOL multigrinder MGLQ and the benefits for their spinning mill.

**Spinnovation: What has your experience with the multigrinder MGLQ been like so far?**

Caldana: The multigrinder MGLQ is very intuitive and easy to use. Thanks to the excellent grinding quality of the spinning top rollers and preparation cylinders, this multipurpose grinding machine has significantly enhanced the performance of our spinning plant.

**Why did you choose a BERKOL model?**

Caldana: We know BERKOL as a precise machine – it's fast and has an excellent ergonomic design. So we had no doubts about deciding for Bräcker again.



Service equipment operator Mrs. Denise Bombardieri appreciates the ergonomic design of the machine

**What effect has it on quality?**

Baroni: The multigrinder's grinded rollers genuinely enable us to achieve consistent yarn quality, which we always have under control. Moreover, thanks to the grinding quality – together with other BERKOL machines such as the press, the Berkolizing unit and the lubrication unit – we are confident that the yarn is produced in the best possible way right from the start.

**How would you summarize the key benefits?**

Caldana: Operating the machine is as intuitive as using a mobile phone. The machine works reliably and accurately.



Mr. Dante Caldana, Spinning Manager



We have not had a single malfunction since purchasing it. Another plus point is the ergonomic design of the machine, which is very much appreciated by our operators.

**Would you recommend the multigrinder to other spinners and why?**

Caldana: Certainly yes! Summarized in three simple words, this grinding machine is robust, reliable and easy to use. Our investment has definitely paid off.

Bräcker TITAN rings, in perfect combination with Bräcker ring travellers, have successfully been used on CENE's ring spinning machines for decades. The TITAN rings are ideally suited to a wide variety of applications and constantly changing yarn counts, from medium to fine.



Massimo Landi  
Senior Sales Manager

**Bräcker**

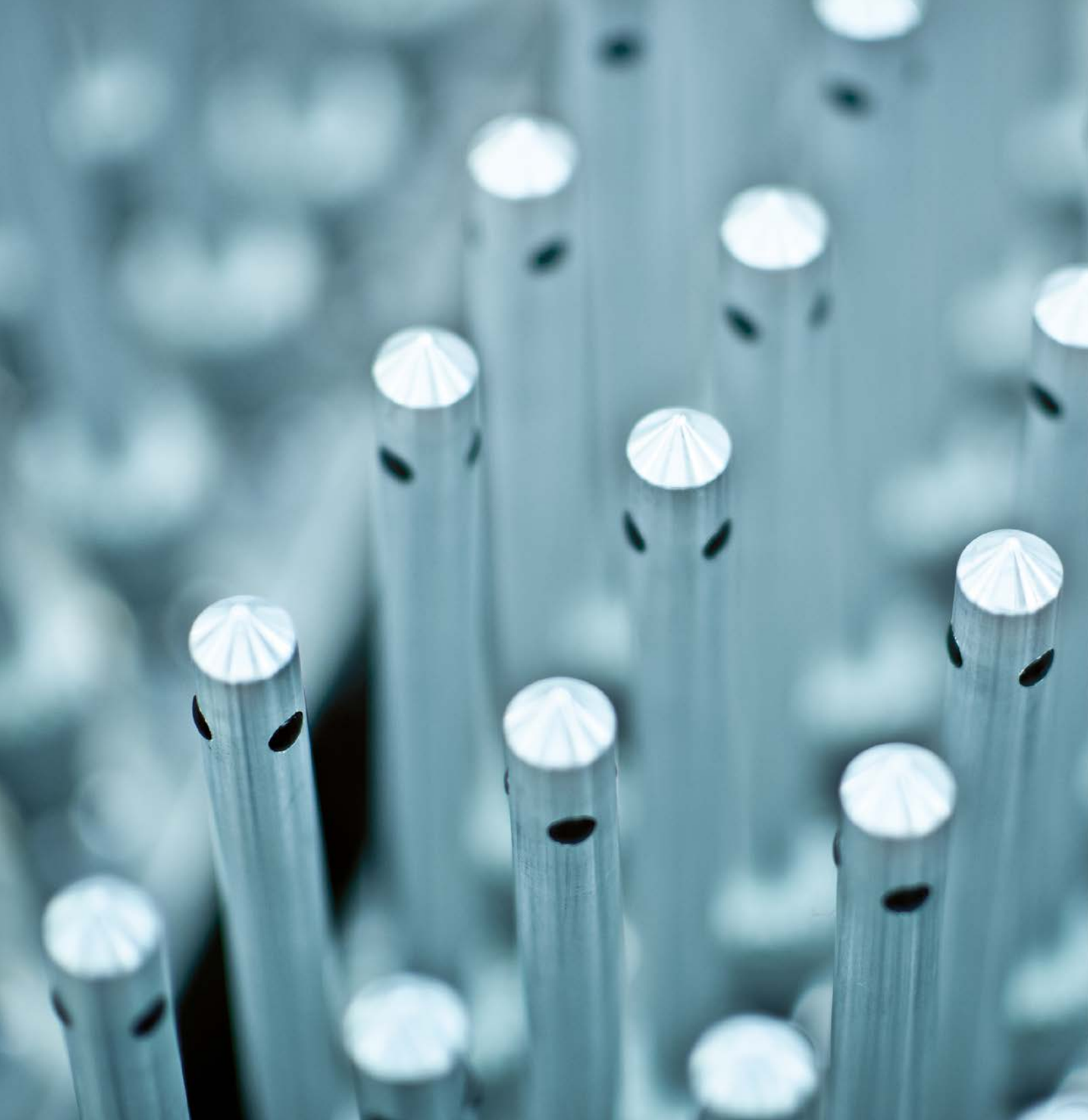

## **Bräcker**

Bräcker AG  
Obermattstrasse 65  
8330 Pfäffikon-Zürich  
Switzerland  
[www.bracker.ch](http://www.bracker.ch)



Graf + Cie AG  
Bildaustrasse 6  
8640 Rapperswil  
Switzerland  
[www.graf-companies.com](http://www.graf-companies.com)

## **Novibra**

Novibra Boskovice s.r.o.  
Na Kamenici 2188  
68001 Boskovice  
Czech Republic  
[www.novibra.com](http://www.novibra.com)



SSM Schärer Schweiter Mettler AG  
Rütihof 8  
8820 Wädenswil  
Switzerland  
[www.ssm.ch](http://www.ssm.ch)

## **Suessen**

Spindelfabrik Suessen GmbH  
Donzdorfer Strasse 4  
73079 Süssen  
Germany  
[www.suessen.com](http://www.suessen.com)